

INSTALLATION INSTRUCTIONS—LED DIE CAST COMBO

READ AND FOLLOW ALL SAFETY INSTRUCTIONS

IMPORTANT SAFEGUARDS: When using electrical equipment, basic safety precautions should always be followed, including the following:

1. Do not use outdoors.
2. Do not let power supply cords touch hot surfaces.
3. Do not mount near gas or electrical heaters.
4. Equipment should be mounted in locations and at heights where it will not readily be subjected to tampering by unauthorized personnel.
5. Use caution when servicing batteries. Battery acid can cause burns to skin and eyes. If acid is spilled on skin or eyes, flush acid with fresh water and contact a physician immediately.
6. The use of accessory equipment not recommended by the manufacturer may cause an unsafe condition. Any modification or use of non-original components will void the warranty and product liability.
7. Do not use this equipment for other than intended use.
8. Servicing of this equipment should be performed by qualified service personnel only.
9. Disconnect AC power supply before servicing.
10. Unpack and check for concealed transit damage.
11. Report any transit damage to delivering carrier and file claim.



SAVE THESE INSTRUCTIONS!

WARNING: MAKE SURE THAT POWER IS OFF BEFORE MAKING ANY ELECTRICAL CONNECTIONS!

- WHITE: Return for 120VAC or 277VAC wiring
- BLACK: Hot lead for 120VAC wiring
- RED/ORANGE: Hot lead for 277VAC wiring
- GREEN: Equipment ground

1. Make sure that all wires are carefully tucked away from the cavity behind the plastic inset.
2. Plug the mating connector of the battery to the PC board.
3. Unused wires must be capped using enclosed wire nuts.

WIRING DIAGRAM

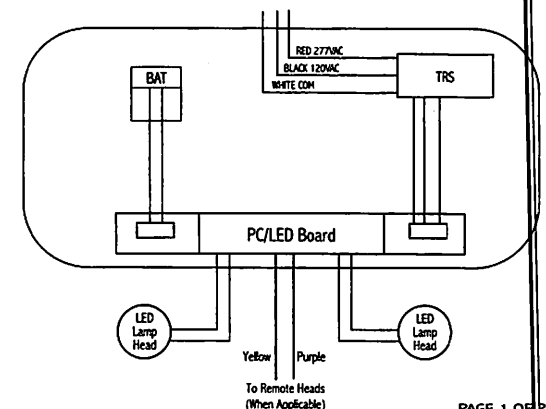

SAVE THESE INSTRUCTIONS!

CANOPY MOUNTING (Top or End mount):

1. To remove face plate cover, squeeze 'clear' lamp lenses and pull down on them (Figure F). Refer to Figure G to see how the unit will appear once the lenses have been removed. Stainless steel clips hold the face plate into place. Simply pop the face plate off by lifting from the bottom (see Figure H).
2. Pop out the mounting hole cover on the top or the side of the sign. Place one of the nuts from threaded stem rod (provided with parts bag) in the slot inside the housing just inside of the unit (Figure A).
3. Feed the AC supply and ground wire through the nut & hole and out of the sign housing (Figure B).
4. Secure the canopy J-Box cover to the mount area of the exit sign by inserting it and shifting it over to align the hole.
5. Feed AC supply wires and ground wire through threaded stem and screw stem into nut inside unit. Screw the remaining nut for the threaded stem onto the stem and tighten securely to complete the mounting of the canopy to the exit sign (Figure C).
6. Determine the position the exit needs to be mounted (the way the face needs to be pointed). Use the included round J-Box mounting plate and small #8-32 screws to accomplish (Figure D).
7. Make connection with the AC supply wires in the J-Box as described in the electrical connection section of this instruction.
8. Now mount the sign to the J-Box plate with the (2) #8-32 screws provided and tighten securely (Figure E).
9. Remove the proper chevron(s) from the EXIT legend(s) if necessary.
10. Attach battery jumper wire to PC board and replace face plate back on unit, and snap the lamp head lenses back on to complete installation.

FLUSH MOUNTING

1. To remove face plate cover, squeeze 'clear' lamp lenses and pull down on them (Figure F). Refer to Figure G to see how the unit will appear once the lenses have been removed. Stainless steel clips hold the face plate into place. Simply pop the face plate off by lifting from the bottom (see Figure H).
2. Remove the center KO and also required KOs that will match the junction box.
3. Route the wires through the center knock-out. Make electrical connections inside the junction box as described in the electrical connection section of this instruction sheet. Push wires back against the back of the sign to minimize any of the wires interfering with the illumination of the letters.
4. Now mount the sign to the J-Box.
5. Remove the proper chevron(s) from the EXIT legend(s) if necessary.
6. Attach battery jumper wire to PC board and replace face plate back on unit, and snap the lamp head lenses back on to complete installation.

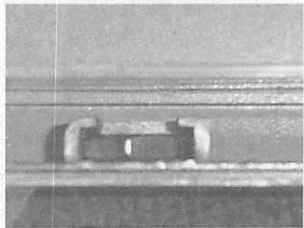

FIGURE A

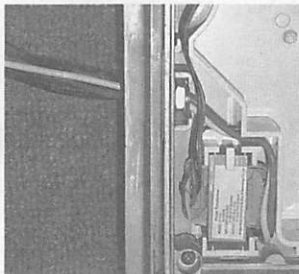

FIGURE B

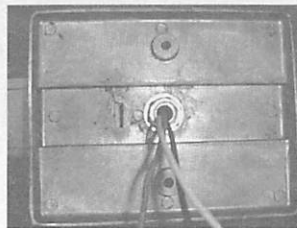

FIGURE C

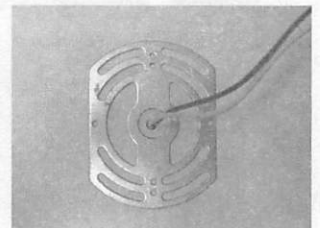

FIGURE D

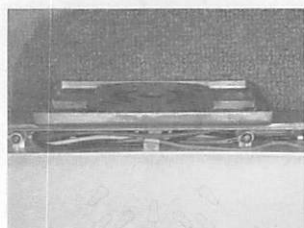

FIGURE E



FIGURE F



FIGURE G

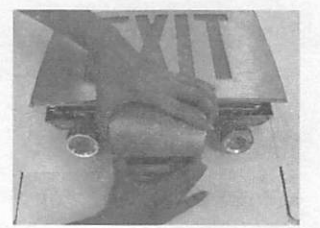

FIGURE H